

The Dash Delivery System



Model: Dash 2.6 & 4.6



OPERATOR'S MANUAL

www.phiber.ca

Limitation of Liability

PhiBer® Manufacturing Inc. shall not be liable for special, incidental, or consequential damages arising out of the use of, the misuse of, or the inability to use any product sold by PhiBer® Manufacturing Inc. including, but without limitation: damages or loss of other property or equipment, personal injury, loss of life, loss of profits or revenue, or claims of purchaser for any such damage or loss.

Warranty

PhiBer® Manufacturing Inc. warrants its products to be free from defect in factory workmanship and material under normal use and service when set-up and operated according to factory instructions. Warranty should be managed through PhiBer® or an authorized selling dealer. Warranty is subject to the following conditions:

Warranty Claims: Must be completed within 30 days of replacement of part(s). Claim must include serial number of Dash, date of delivery, explanation of problem and all other necessary particulars.

Warranty Parts: Must be kept for PhiBer's® inspection unless otherwise specified.

Warranty Labor: PhiBer® must authorize any labor subject to warranty. PhiBer® Manufacturing Inc. reserves the right to set the labor rate and time required to complete a warranty repair.

Warranty Limitations: Warranty will not be granted on any product that has been misused, altered, or modified in any way. Diagnostic and service calls are not covered by warranty. Warranty covers only the cost of repair and parts; it does not include shop supplies, mileage, and freight costs.

Government Legislation: Warranty terms and conditions are subject to provincial or state legislation and laws.

Warranty on cylinders, hydraulic components, electronic components, and other trade accessories are limited to the warranties made by the respective manufacturers and not by PhiBer® Manufacturing Inc.

The following table shows the available warranty:

Item	Time from Purchase
Frame and other structural components	One (1) Year
Electronic components	One (1) Year
Hydraulic components	One (1) Year
Hydraulic cylinders	One (1) Year

Table of Contents

TABLE OF CONTENTS	III
INTRODUCTION	1
DESCRIPTION OF THE MACHINE.....	2
ILLUSTRATION OF THE MACHINE	2
<i>Dash</i>	2
<i>Serial Number Location</i>	3
SAFETY	4
SAFETY ALERT SYMBOLS	4
SIGNAL WORDS	4
OPERATOR RESPONSIBILITY	5
<i>Key Safety Reminders:</i>	5
GENERAL SAFETY PRACTICES	5
MAINTENANCE SAFETY	6
WATER AND CHEMICAL SAFETY	7
INSTALLATION SAFETY.....	8
TRANSPORT SAFETY	8
STORAGE SAFETY.....	9
SAFETY SIGNS	10
<i>Safety Sign Location</i>	10
<i>Safety Sign Explanation</i>	10
<i>Road Safety Sign Location</i>	11
<i>Road Safety Sign Explanation</i>	12
<i>Safety Sign Maintenance</i>	12
SPECIFICATIONS	13
DASH	13
TORQUE SPECIFICATIONS.....	14
MOUNTING AND INSTALLATION	15
MOUNTING THE DASH	15
4.6 <i>Center Mount</i>	15
2.6.....	15
1.6 <i>Primary</i>	15
1.6 <i>Secondary</i>	16
MOUNTING THE DASH ACCESSORIES	16
<i>Cage</i>	16
<i>Cage Transfer Hose</i>	16
<i>Bag Holder Kit</i>	17
<i>Tote Platform (4.6 only)</i>	17
<i>Ladder Kit</i>	17
<i>Tote Rinse Kit</i>	18
<i>Tote Transfer Hose</i>	18
<i>Platform Cargo Net Kit</i>	18
<i>Tote Strap Kit</i>	19
<i>Light Kit</i>	19
<i>Trailer Lighting Kit</i>	19

<i>Boom Kit</i>	19
<i>Second Boom Kit</i>	20
<i>Boom Blow Out Kit</i>	20
<i>Fire Nozzle Kit</i>	20
<i>Trailer Step Kit</i>	21
<i>Manifold Kit</i>	21
<i>Deck Bulkhead</i>	21
<i>Auxiliary Chemical Meter (2.X only)</i>	21
<i>Jug Knife Kit</i>	22
<i>Electric Hose Reel</i>	22
<i>Chemical Transfer Pump</i>	22
<i>Water Tanks</i>	22
<i>Dry Mix Agitate</i>	22
<i>Gas Can Kit</i>	23
<i>Aux Fill Kit (Side/Rear)</i>	23
<i>Tank Fill (¾/ 2")</i>	23
<i>Fuel Tank</i>	23
<i>Free Standing Tote Deck</i>	24
<i>Filter Kit</i>	24
<i>Ramp Kit</i>	24
<i>Air Tank Kit</i>	24
OPERATION	25
PRE-LOADING PRODUCTS.....	25
<i>Jugs and Liquid Products</i>	25
<i>Dry Products</i>	26
LOADING THE SPRAYER.....	26
CLEANING THE DASH	27
SERVICE AND MAINTENANCE	28
WINTERIZING	28
SPRINGTIME PREPARATION	29
REAR MOUNT DASH LIGHT SCHEMATIC	31
TROUBLESHOOTING	32
INDEX	33

Introduction

Congratulations on your purchase of the PhiBer® Dash Delivery System. The PhiBer® Dash Delivery System offers the agricultural industry a machine for quickly mixing and loading spraying chemicals.

All persons authorized to operate this equipment should read and understand the contents of this Operator's Manual, especially the *Safety* section. The owner or operator should seek assistance from the dealer, distributor or PhiBer® for any information not fully understood regarding the safe operation, adjustment, maintenance, or repair of this equipment.

Keep this Operator's Manual in a clean, dry place that is easily accessible for reference when more detailed information is required to perform tasks related to the operation, adjustment, maintenance, or repair of this equipment. It is further recommended that the contents of this Operator's Manual be reviewed at least annually by persons operating, adjusting, maintaining, or repairing this PhiBer® Dash Delivery System and any time a new person is assigned to any of the above-mentioned tasks.

Any information in this Operator's Manual that is not fully understood should be clarified by contacting the dealer, distributor, or manufacturer.

The contents of this Operator's Manual are accurate up to the time of printing.

PhiBer® reserves the right to make design changes without prior notice to the end user.

Description of the Machine

The Dash has two primary objectives; reduce fill times to keep the sprayer spraying, and to keep chemicals separated. The Dash 4.6 comes with two pumps, a high delivery water pump with a 13hp Honda motor and air diaphragm pump capable of 94 gpm used for auto rinsing and the agitation of dry products. The Dash 2.6 comes with two pumps, a high delivery water pump with a 13hp Honda motor and air diaphragm pump capable of 40 gpm used for auto rinsing and the agitation of dry products. The design allows operators to load multiple products for the next sprayer load ahead of time while keeping chemicals separated. Once connected to the sprayer, the operator can stand at the side of the trailer, completely loading the sprayer with up to four different products without moving. The process of loading four different chemicals into a 1,200-gal sprayer can take less than four minutes.

Illustration of the Machine

Dash

- | | |
|-----------------------------|--------------------------|
| 1. Battery | 7. 1" or 1-1/2" Water In |
| 2. Gas Engine/ Suction Pump | 8. 3" Water in |
| 3. Chemical Dump Handles | 9. Lifting points |
| 4. Chemical Inductor | |
| 5. Air Diaphragm Pump | |
| 6. Air Input | |

[TW1][TW2]

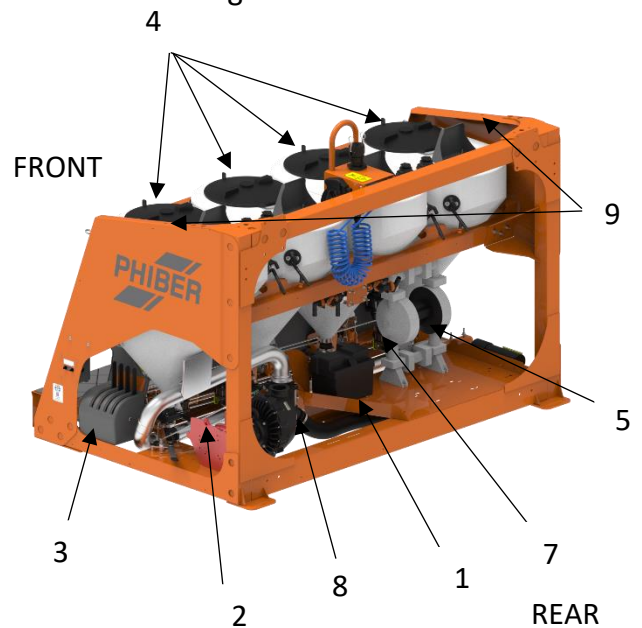
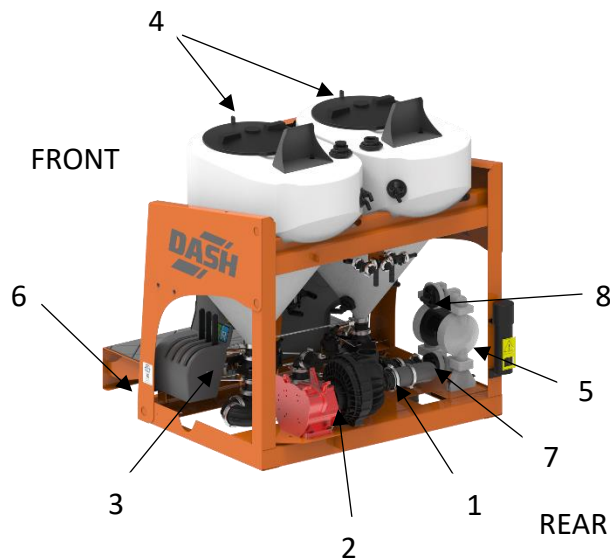
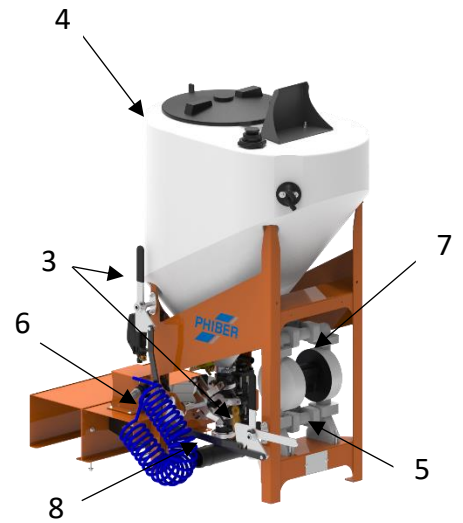

Serial Number Location

The serial number plate (Figure 1.2) is located on the left-hand side of the frame.

Record the machine Model and Serial Number in the spaces provided below. Use these numbers when contacting the dealer for repair parts or service assistance.

Model Number: _____

Serial Number: _____

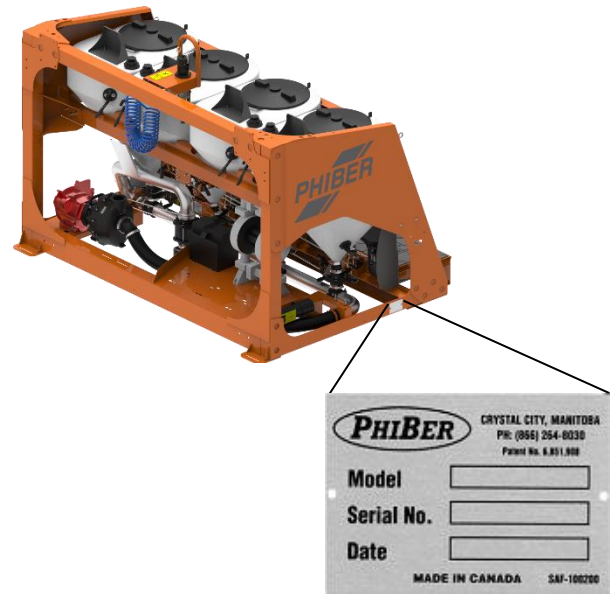

Figure 1.2

Safety

Safety Alert Symbols

Safety Alert Symbols are intended to draw attention of the machine operator to important safety information both published in the Operator's Manual and applied to the machine. Whenever a Safety Alert Symbol is seen, it means that associated information is provided for recognizing, responding appropriately to, and avoiding potentially hazardous situations.

An equilateral triangle surrounding an exclamation point or a double line equilateral triangle surrounding symbols or graphics indicates a potentially hazardous situation. Information included on a safety sign or printed in the Operator's Manual describes the hazardous situation and indicates appropriate response and/or avoidance procedures.

Remember:

**ACCIDENTS DISABLE AND KILL
ACCIDENTS ARE COSTLY
ACCIDENTS CAN BE AVOIDED**

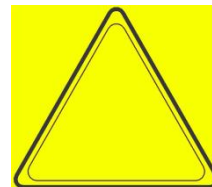

Signal Words

DANGER

Indicates an imminently hazardous situation that, if not avoided, **WILL** result in death or severe injury if proper precautions are not taken.



WARNING

Indicates a potentially hazardous situation that, if not avoided, **COULD** result in death or severe injury if proper precautions are not taken.



CAUTION

Indicates a potentially hazardous situation that, if not avoided, **MAY** result in minor or moderate injury if proper precautions are not taken, or it serves as a reminder to follow appropriate safety practices.



Operator Responsibility

Remember, YOU, the operator, are responsible for the safe operation, adjustment, maintenance, and repair of this PhiBer® Dash Delivery System. It is the responsibility of the owner, or authorized person in charge, to ensure that all persons who operate, adjust, maintain and/or repair this implement are familiar with the information provided in this Operator's Manual.

A safe operator is the key to safety. Good safety practices not only protect you, but also persons who may be near the DASH. Make good safety practices a part of your farming operation. Ensure that all persons operating, adjusting, maintaining and/or repairing this equipment are familiar with the procedures recommended in this Operator's Manual.

Always heed safety warnings and follow recommended safety precautions to avoid hazardous situations. Do not risk personal injury or death by ignoring safety warnings and safety precautions.

Key Safety Reminders:

- The most important safety device is a safe and qualified operator.
- A safe operator is one who has read and understood the contents of this Operator's Manual prior to performing any tasks related to the machine.
- Owners have a responsibility to provide training to persons who may operate, adjust, maintain and/or repair the equipment prior to performing any of these tasks.
- Do not perform any unauthorized modifications to the Dash or use the Dash for any purpose other than what is described in the contents of this Operator's Manual.
- Plan tasks and work schedules to reduce exposure to unnecessary stress and fatigue.
- Observe all workplace safety and health requirements.
- Read all supplied products manuals.

General Safety Practices

- Read and understand the contents of this Operator's Manual prior to operating, adjusting, maintaining and/or repairing the Dash.
- Locate, read, and understand all safety signs applied to the Dash before performing any tasks.
- Review the contents of this Operator's Manual at least annually, and any time a new person is assigned to perform any task with the Dash.

- Do not allow riders on any part of the Dash or trailer.
- Ensure all guards and shields are intact and in place prior to operating the Dash.
- Keep hands, feet, hair, and loose clothing away from moving and/or rotating parts.
- Ensure that any nearby oil, fuel, or other liquid spills are dried and cleaned before starting the engine.^[TW3]
- Stop the engine, remove the ignition key, and allow time for moving parts to stop prior to adjusting, maintaining, or repairing the equipment.
- Ensure that all equipment lighting, and marking is intact, clean, and operating properly prior to traveling on public roads. Check with local highway authorities to confirm that the Dash is properly equipped for highway travel.
- Provide a fully stocked First-Aid kit in a highly visible and easily accessible location.
- Keep a fully charged fire extinguisher in a highly visible and easily accessible location.
- Ensure that the Dash is securely blocked and supported prior to working underneath (if it needs to be raised for repair).
- Ensure that all persons operating, adjusting, maintaining and/or repairing the Dash know how to seek or summon medical assistance should an injury occur.
- Ensure deck remains clean and dry to reduce slipping/tripping.
- Do not climb onto tote deck or cage, use ladder from ground to secure tote straps.
- Only allow one operator at any time.
- Use caution when using jug knives.

Maintenance Safety

- Read and understand all the information provided in this Operator's Manual and provided OEM Manuals covering the operation, adjustment, maintenance, and repair prior to performing any of these tasks.
- Ensure proper tools, equipment and personal protective equipment is available prior to working on the Dash.

- Stop the engine, remove the ignition key, and allow time for moving parts to stop prior to adjusting, maintaining, or repairing the equipment.
- Ensure that all moving parts have come to a complete stop before performing adjustments, maintenance, or repairs.
- Prior to operating equipment, ensure that all guards and shields are intact and in place after performing adjustment, maintenance, or repairs.
- Check for bushing wear and weldment fatigue on moving parts.
- Store flammable fluids in approved containers and store out of access by unauthorized persons, especially children.
- Wear appropriate clothing when performing tasks around the Dash. Ill-fitting and/or frayed clothing as well as loose or dangling items should not be worn when working near the equipment.
- Ensure that pressure in hoses, lines and components is fully relieved prior to performing maintenance or repairs to the system.

Water and Chemical Safety

- Periodically inspect condition of hoses, lines, and components. Remove and replace any parts showing damage or deterioration.
- Use only repair or replacement parts specified by the manufacturer.
- Follow instructions provided by the manufacturer when making repairs.
- Wear appropriate personal protective equipment when unsure if residual pressure may exist in components during troubleshooting and/or making repairs.
- Wear appropriate personal protective equipment when handling chemicals.
- Ensure all fittings, couplings and other connections are intact and properly tightened before operation.

- Store flammable/ toxic fluids in approved containers and store out of reach by unauthorized persons, especially children.
- Ensure that pressure in hoses, lines and components is fully relieved prior to performing maintenance or repairs to the fluid system.
- Ensure that all persons operating, adjusting, maintaining and/or repairing the Dash know how to seek or summon medical assistance should an injury occur.
- Insecticide should be poured directly into sprayer tank to limit exposure.
- Follow all local regulations for chemical spills.
- Follow all chemical manufacturer's instructions for use and safety.



Installation Safety

- Read, review, and understand all Dash installation instructions before attempting to attach Dash to trailer.
- Ensure the trailer is properly hitched to the tractor.
- Ensure that tractor engine is shut off, key is removed from the ignition and the parking brake is set and/or wheels blocked.

Transport Safety

- Ensure that the Dash, Dash accessories, and all loads or chemical totes are attached to the trailer according to local regulations.
- Ensure the trailer hitch is in place and engaged properly.
- Ensure all lighting and implement marking devices are intact and visible.
- Ensure equipment is properly marked according to local road regulations and heed all local traffic regulations.
- Ensure trailer dimensions and weight is within local regulations.
- Reduce travel speed on rough roads and surfaces.

- Come on and off approaches or roads slowly; too much speed can cause the trailer to tip.
- Use additional caution and reduce speed when towing under adverse surface conditions and when turning.
- Do not allow riders on any part of the Dash or trailer.
- Ensure boom, cage doors, trailer steps, and end gate is securely latched before transport.
- Ensure main air valve to dash is turn off prior to transport.
- Ensure any work lights on dash are turned off prior to transport.
- If lifting the DASH, use the designated lifting points^[TW4] (refer to page 2)

Storage Safety

- Store the Dash away from areas of human activity.
- Do not allow children to play on or around Dash or trailer.
- If freezing temperatures are likely, fully winterize before storage.

Safety Signs

Safety Sign Location

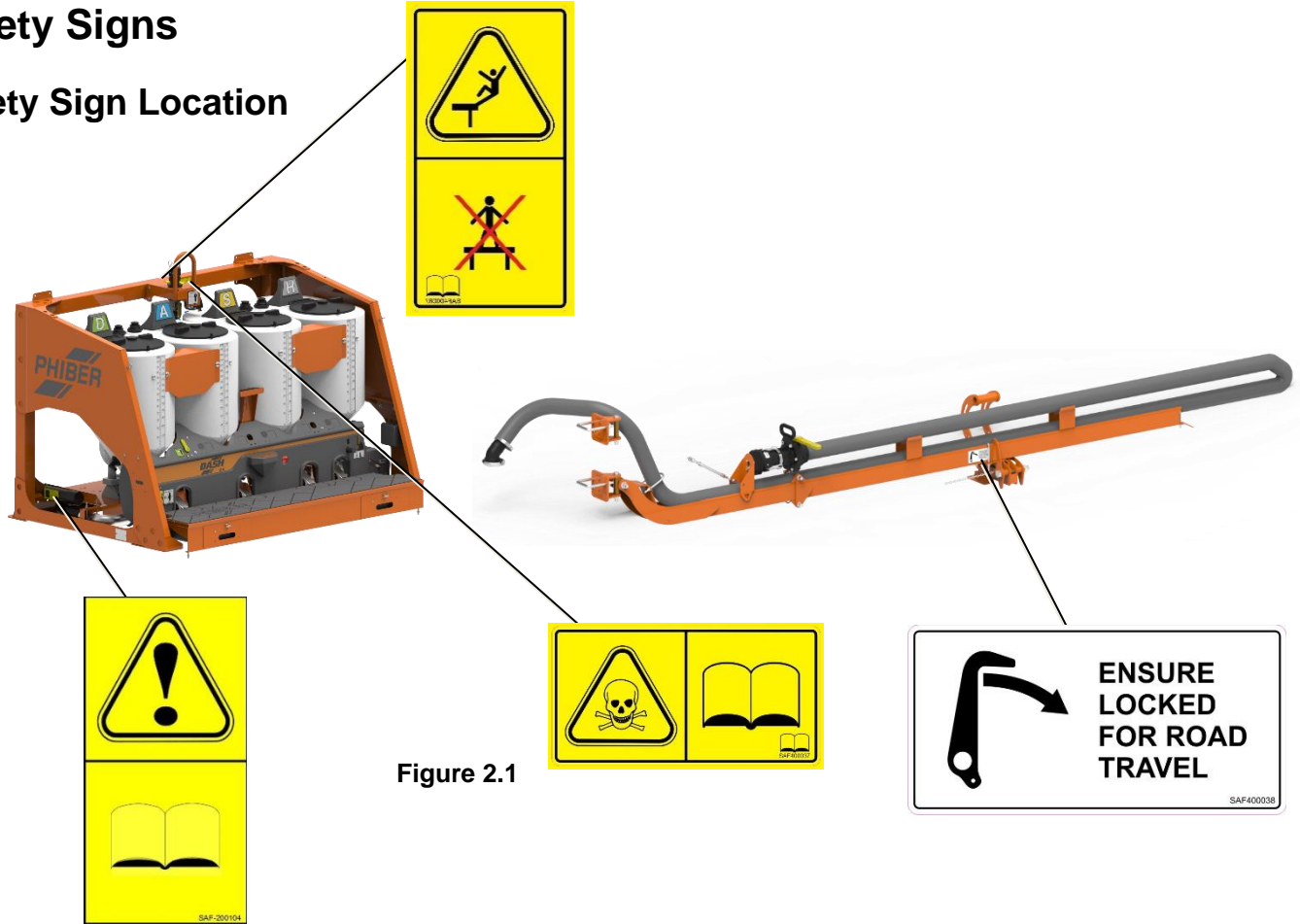

Safety Sign Explanation

BOOM LATCH (Figure 2.2)

 **WARNING!** Ensure boom is securely latched before transport.



READ THE OPERATOR'S MANUAL (Figure 2.3)

! **WARNING!** Read and understand the contents of the Operator's Manual before performing any tasks related to the operation, adjustment, maintenance, or repair of the machine.

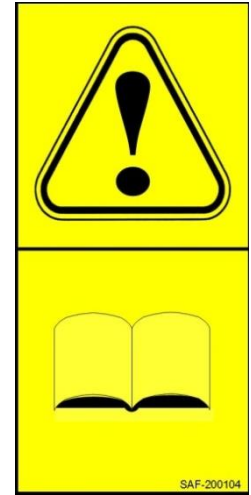

Figure 2.3

CHEMICAL HAZARD (Figure 2.4)

! **WARNING!** Read and understand the contents of the chemical manufacturers handling and use instructions.

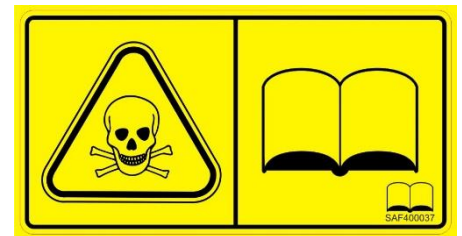

Figure 2.4

FALLING HAZARD (Figure 2.4)

! **WARNING!** Do not climb onto Tote Platform.



Figure 2.5

Road Safety Sign Location

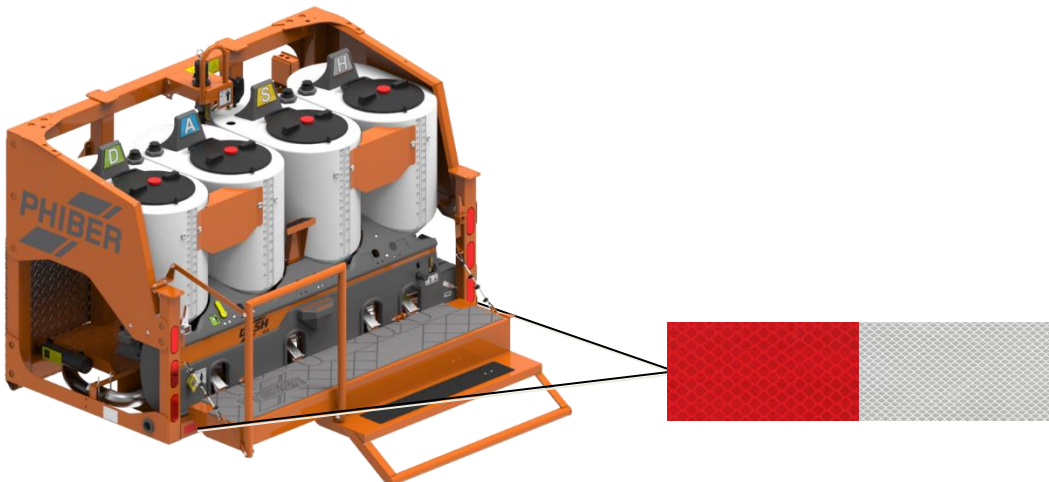

Road Safety Sign Explanation

CONSPICUITY TAPE- RED/WHITE (Figure 2.12)

Tape serves as reflectors to make vehicle visible in low light or dark driving conditions.



Figure 2.12

Safety Sign Maintenance

Safety Sign Legibility

All safety signs applied to the Dash must be visible and legible. Keep dust and dirt cleared from safety signs and ensure that visibility is not obscured.

Damaged or Deteriorated Safety Signs

Remove and replace any safety signs that have been damaged or show signs of deterioration.

Safety Sign Replacement

Replacement safety signs may be ordered through your dealer or distributor. Contact PhiBer® if you are unable to obtain replacement safety signs from a dealer or distributor.

Safety Signs on Replacement Parts

Ensure that replaced parts or components on the Dash, which had a safety sign attached originally, include a safety sign when they are shipped to you.

Affixing Safety Signs to Machine

1. Ensure proper position and orientation before installing.
2. Ensure installation area is clean and dry.
3. Ensure ambient temperature is above 50° F (10° C).
4. Remove backing material to expose label adhesive.
5. Place one edge of label to machine surface.
6. Slowly press the label onto the surface.
7. Ensure no air pockets exist under surface of the label.

Specifications

DASH

	<u>1.6</u>	<u>2.6</u>	<u>Center Mount 4.6</u>	<u>Rear Mount 4.6</u>
Width	26 in (66 cm)	56 in (141 cm)	99 in (250 cm)	99 in (250 cm)
Length	54 in (137 cm)	61 in (154 cm)	62 in (158 cm)	60 in (152 cm)
Height	61 in (155 cm)	55 in (138 cm)	62 in (156 cm)	62 in (156 cm)
Dry Weight	120 lbs. (54 kg)	600 lbs. (272 kg)	1230 lbs. (560 kg)	1860 lbs. (844 kg)
Requirements	3" Water Supply Line, 1" Water Supply Line, 3/8" Air Line	3" Water Supply Line, 1" Water Supply Line, 3/8" Air Line	3" Water Supply Line, 1-1/2" Water Supply Line, 3/8" Air Line	

Torque Specifications

SAE

Bolt Diameter	Bolt Torque		
	SAE 2 N·m (lb-ft)	SAE 5 N·m (lb-ft)	SAE 8 N·m (lb-ft)
1/4	8 (6)	12 (9)	19 (12)
5/16	13 (10)	25 (19)	36 (27)
3/8	27 (20)	45 (33)	63 (45)
7/16	41 (30)	72 (53)	100 (75)
1/2	61 (45)	110 (80)	155 (115)
9/16	95 (70)	155 (115)	220 (165)
5/8	128 (95)	215 (160)	305 (220)
3/4	225 (165)	390 (290)	540 (400)
7/8	230 (170)	570 (420)	880 (650)
1	345 (225)	850 (630)	1320 (970)

Metric

Bolt Diameter	Bolt Torque	
	8.8 N·m (lb-ft)	10.9 N·m (lb-ft)
M3	0.5 (0.4)	1.8 (1.3)
M4	3 (2.2)	4.5 (3.3)
M5	6 (4)	9 (7)
M6	10 (7)	15 (11)
M8	25 (18)	35 (26)
M10	50 (37)	70 (52)
M12	90 (66)	125 (92)
M14	140 (103)	200 (148)
M16	225 (166)	310 (229)
M20	435 (324)	610 (450)
M24	750 (555)	1050 (774)
M30	1495 (1103)	2100 (1550)
M36	2600 (1917)	3675 (2710)

Valve Bolts

Valve Size	Nut Size across flats	Handle Bolt Torque	Body Bolt Torque
in	in	N·m (in-lb)	N·m (in-lb)
3/4	7/16	5 (45)	5 (45)
1	1/2	5 (45)	5 (45)
2	9/16	17 (150)	10 (88)
3	9/16	28.3 (250)	10 (88)

NOTE: Torque values listed are based on lubricated connections in reassembly.

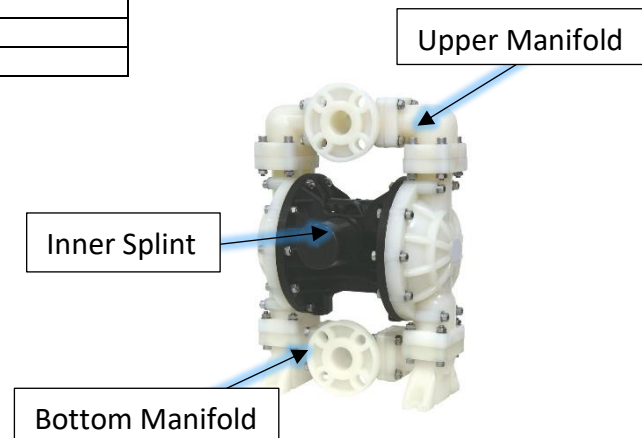

Chemical Transfer Pump

Pump	Liquid cover-Inner Splint	Liquid Cover-Upper Manifold	Liquid Cover-Bottom Manifold
	N·m (in-lb)	N·m (in-lb)	N·m (in-lb)
RD25 (1")	5.5-6.5 (49-58)	5-6 (45-54)	5-6 (45-54)
RD40(1.5")	8.5-10 (76-89)	5-6 (45-54)	5-6 (45-54)

Mounting and Installation

Mounting the DASH

4.6 Center Mount

1. Place Dash on trailer where desired.
2. Drill 11/16" holes through trailer railing through Dash feet.
3. Secure Dash using 5/8" carriage bolts (of the appropriate length for the mounting surface) through Dash feet. (Figure 4.1)
4. Attach 3" water line to suction supply line.
5. Attach 1-1/2" water supply line to rinse source valve.
6. Attach 3/8" airline to air supply line.
7. Attach 3" output hose to outlet flange.
8. Use 3/8" bolts to bolt Working Platform onto Dash frame.
9. [TW5] Insert deck screws through bottom flange of platform to secure to trailer deck.
10. Detach mounting bracket from hose and use it to secure 3" suction hose to deck (refer to the below images) [TW6]



Figure 4.1-Mounting Feet

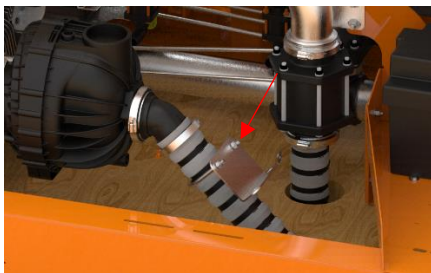

Working Platform

2.6

1. Place Dash on trailer where desired.
2. Drill 11/16" holes through trailer through Dash feet. If not mounting to trailer rail, ensure that trailer decking is in good condition.
3. Secure Dash to trailer using 5/8" bolts.
4. Attach 3" water line to suction supply line.
5. Attach 1" water supply line to rinse source valve.
6. Attach 3/8" airline to air supply line.
7. Attach 3" output hose to outlet flange.

1.6 Primary

1. Place Dash on trailer where desired.
2. Drill 1/2" holes through trailer through Dash feet, if not mounting to trailer rail ensure that trailer decking is in good condition.

3. Secure Dash to trailer using 1/2" bolts.
4. Attach 3" water supply hose to hose barb. **Note that the pump pulls water toward the sprayer, rather than pushing it.**
5. Attach 1" water supply line to rinse source valve.
6. Attach 3/8" airline to air supply line.
7. Attach 3" output hose to hose barb.

1.6 Secondary

1. Place Dash on trailer beside primary where desired.
2. Bolt work steps together through supplied holes.
3. Drill 1/2" holes through trailer through Dash feet, if not mounting to trailer rail ensure that trailer decking is in good condition.
4. Secure Dash to trailer using 1/2" bolts.
5. Attach closest 3" hose barb to Primary hose barb.
6. Attach 3" water supply or output hose to other hose barb.
7. Remove one hose barb from air diaphragm pump outlet on Primary.
8. Attach supplied nipple, tee and hose barb in port created in last step.
9. Attach removed hose barb into empty port in tee.

Mounting the DASH Accessories

Cage

1. Place Cage on trailer where desired.
2. Drill 11/16" holes through trailer deck through Cage feet.
3. Secure Cage using 5/8" carriage bolts of appropriate length through Cage feet. (Figure 4.1)



Cage Transfer Hose

Refer to Quick Start Guide **DOC400051** for detailed instructions.

1. Center Containment Mount Weldment over center tube on sliding door side of Cage.
2. Drill holes in Cage through holes in weldment.
3. Attach weldment to Cage using self-tapping screws.

4. Drill 2-1/2" hole through trailer deck under containment weldment and under tote deck near dash.
5. Attach QDC fittings to one end of hose.
6. Attach hose to desired tote.
7. Run hose to weldment and down cage front through hole in deck.
8. Secure hose to cage with containment bracket.
9. Run hose under the deck up through the previously drilled hole under tote deck.
10. Attach QDC fittings with valve to other end of hose.
11. Run the hose to either the top of desired inductor or desired aux chemical pump.

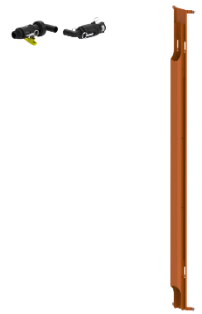

If attaching to inductor,

12. Remove the membrane in desired spin-on-fitting. Ensure no plastic remains in the tank.
13. Thread 1-1/2 male quick disconnect fitting into spin-on-fitting.

Bag Holder Kit

Refer to Quick Start Guide **DOC400061** for detailed instructions.

1. Place Bag Holder onto roof cross beam inside the sliding door of the Cage.
2. Drill 5/16 holes through the tube, using bag holder as template.
3. Use supplied 1/4 bolts to attach bag holder to tube.
4. Insert bag through bag holder, securing bag with strap around bag holder.
5. Insert used jugs into bag.
6. When bag is full, detach strap securing bag; remove bag; tie and dispose of at desired recycling plant.



Tote Platform (4.6 only)

1. Use supplied 1/2" carriage bolts to bolt Platform legs to Platform.
2. Use supplied 1/2" carriage bolts to bolt Tote Platform to Dash.
(Figure 4.2)
3. Drill 11/16" holes through trailer deck through Platform feet.
4. Insert 5/8"x 2" carriage bolts through Platform feet. (Figure 4.1)



Figure 4.2-Tote Deck attached to Dash.

Ladder Kit

Refer to Quick Start Guide **DOC400046** for detailed instructions.

1. Attach hanger brackets to mounting holes in Tote Platform using supplied fasteners.

2. Hang ladder from on the brackets.

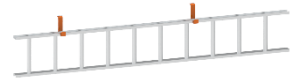

Tote Rinse Kit

Refer to Quick Start Guide **DOC400050** for detailed instructions.

1. Remove lid on desired tote.
2. Place supplied lid with rinse nozzle on tote.
3. Connect hose to supplied lid.
4. When you require rinsing, attach hose to rinse fitting at top of Dash.
5. Turn rinse valve on, using handle on valve.



Tote Transfer Hose

Refer to Quick Start Guide **DOC400043** for detailed instructions.

1. Attach fitting to desired tote. Use a straight barb fitting for front totes, or the right-angle barb for rear totes.
2. Run the hose to either top of desired inductor or desired aux chemical pump. If necessary, disconnect the hose from fittings and cut to length before re-attaching.

If attaching to inductor,

3. Remove the membrane in desired spin-on-fitting. Ensure no plastic remains in the tank.
4. Thread 1-1/2 male quick disconnect fitting into spin-on-fitting.



Platform Cargo Net Kit

Refer to Quick Start Guide **DOC400059** for detailed instructions.

1. Bolt bottom mounting bracket to either Tote Platform leg, ~2.9 from deck, or Dash, through mounting holes, using supplied fasteners.
2. Slide shafts through loops on cargo net, placing stop tube in proper place.
3. Bolt cargo nets to shafts using 5/16 x 2-1/2 bolts.
4. Bolt stop tubes to shafts using 5/16 x 3 bolts.
5. Slide top of shaft up into receiver attached to tote platform.
6. Place bottom of shaft into bottom mounting bracket
7. Close latch around shaft and use lynch pin to secure latch.
8. Repeat step 5-7 for other side of cargo net
9. Repeat step 1-8 for other side of tote deck

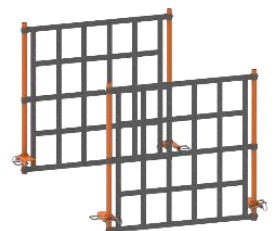
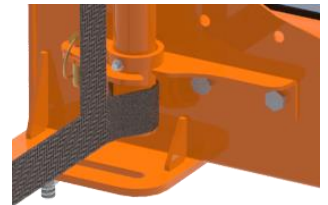

Note: If attaching to a Dash with a Boom, you may be required to disconnect boom hose from pump and thread hose through cargo net, then reattach to pump.

Tote Strap Kit

Refer to Quick Start Guide **DOC400058** for detailed instructions.

1. Put the load (i.e. a tote) onto the tote deck.
2. Put straps into loops on deck.
3. Use the latch to secure load to deck.



Light Kit

Refer to Quick Start Guide **DOC40077** for detailed instructions.

1. Use supplied bolts to bolt Light Kit onto Dash frame through mounting holes.
2. Use included cable to attach lights to appropriate port on the fuse box.
3. Use supplied zip ties to secure wire to Dash frame.



Trailer Lighting Kit

1. Use supplied 3/8" x 1" bolts to bolt Light posts onto Dash frame.
2. Place light brackets in desired locations behind tanks.
3. Use light brackets as a template to drill pilot holes for self-tapping screws.
4. Use supplied self-tapping screws to attach light brackets to dash frame.
5. Insert lights into light brackets.
6. Install spotlights into provided holes in cage and on hose rinse bracket.
7. Mount Switch Box using supplied #10 self-drilling screws.
8. Run wires from lights to the switch box.



Boom Kit

1. If not mounting to Dash frame, bolt Standalone Boom Kit to trailer deck with 1/2" bolts.
2. Use supplied 5/8" U-bolts to bolt Boom Kit onto Dash frame or Standalone Boom Kit. Bottom U-bolt ~17.5" from deck, with ~12.7" in-between U-bolts.
3. Drill 7/16" holes in deck and bolt Boom Latch to deck with 3/8" bolts at desired location.
4. Attach 3" hose to pump flange.



Second Boom Kit

1. If not mounting to Dash frame, bolt Standalone Boom Kit to trailer deck with 1/2" bolts.
2. Use supplied 5/8" U-bolts to bolt Boom Kit onto Dash frame or Standalone Boom Kit. Bottom U-bolt ~17.5" from deck, with ~12.7" in-between U-bolts.
3. Drill 7/16" holes in deck and bolt Boom Latch to deck with 3/8" bolts at desired location.
5. Disconnect existing boom's 3" hose from pump.
6. Attach supplied female quick-disconnect to pump.
7. Attach 3" flange to 3" male quick-disconnect to existing boom.
8. Use quick-disconnect to attach desired boom to pump.

Boom Blow Out Kit

Refer to Quick Start Guide **DOC400062** for detailed instructions.

1. Remove quick disconnect fitting from end of boom hose.
2. Push hose through hose sleeve along with wire, secure hose wrap at boom end under U-bolt or with zip tie and at hose end with zip tie.
3. **Tuck about 6-8" of the wire back into the hose sleeve on both sides**, to prevent damage to the wires when hose stretches under pressure.
4. Attach quick disconnect valve to end of boom hose.
5. Disconnect boom hose from pump.
6. Attach coupling between boom hose and pump.
7. Cut regulated air hose near coupling location and insert supplied airline tee.
8. Use supplied 3/8 airline to attach tee in air supply to check valve on coupling.
9. Run fused 40' wire and 20" wire to battery.
10. Attach loose end of powered wire to port 1 and 3 on solenoid.
11. Attach the last wire to port 2 on solenoid.



Fire Nozzle Kit

1. Attach Fire Hose to quick disconnect fitting on Boom.
2. Turn on the motor and open main water valve.
3. Adjust nozzle to desired spray pattern.



Trailer Step Kit

Refer to Quick Start Guide **DOC400053** (41" deck) or **DOC400054** (34" deck) for detailed instructions.



1. Using included Drill Template, drill the mounting holes through deck at desired location. Align top plates to holes.
2. Bolt Step Brackets loosely underneath top plates and deck using supplied carriage bolts.
3. Insert Steps into Step Brackets using step rod and supplied fasteners.
4. Tighten Step Frame bolts.
5. Use supplied fasteners to attach brace to step frames.
6. Mount Handle to side of trailer, next to steps.

Manifold Kit

1. Drill holes in trailer deck at desired location.
2. Bolt Manifold Kit to trailer.
3. Connect hoses to designated ports on rear of Manifold. (Figure 4.3)

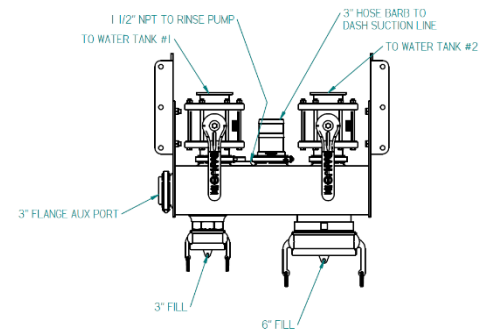

Figure 4.3-Manifold Hose Ports

Deck Bulkhead

Refer to Quick Start Guide **DOC400057** for detailed instructions.

1. Drill 4-1/8" hole in deck at desired position.
2. Place Bulkhead through trailer deck.
3. Drill 7/16" holes through trailer deck using Bulkhead plate as template.
4. Attach flange adapter to bulkhead.
5. Bolt Bulkhead onto the deck using supplied 3/8" fasteners, secured on opposite end with bulkhead plate.
6. Attach flange adapter to opposite side of bulkhead, secure 90" hose barb to both sides with clamps and gaskets.
7. Attach hoses to Bulkhead.



Auxiliary Chemical Meter (2.X only)

1. Bolt Chemical Meter into supplied place in Dash side using supplied 1/4" bolts. (Figure 4.4)
2. Connect 1" hoses to Chemical Meter using supplied hose clamps.



Figure 4.4- Aux. Chemical Meter

Jug Knife Kit

Refer to Quick Start Guide **DOC400076** for detailed instructions.

1. Remove tank lid.
2. Remove jug rinse frame from tank
3. Remove jug rinse nozzle, 1/2" street elbow, and 1/2" x 6" nipple from rinse tube
4. Thread supplied 3/4" 90° hose barb onto end of rinse tube
5. Use fifteen inches of 3/4" hose to attach hose barb to hose barb on Jug Knife frame. (Figure 4.5)
6. Place Jug Knife Frame into tank.
7. Replace tank lid.
8. Attach rinse valve to space in front panel using supplied hardware. (Figure 4.6)

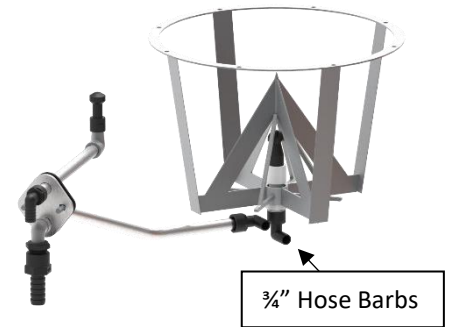

Figure 4.5: Knife Kit Installed

Electric Hose Reel

Refer to Quick Start Guide **DOC400066** and/or hose reel manual for detailed instructions.

1. Bolt Hose Reel on to trailer deck in desired location.
2. Attach hose reel inlet to pump outlet according to hose reel manual.
3. Attach hose reel to battery following recommendations in hose reel manual.

Chemical Transfer Pump

1. Bolt Chemical Transfer Pump on to Dash bottom using 5/16" bolts.
2. Attach hoses to the pump.
3. If pump leaks, torque according to specifications on page 14.

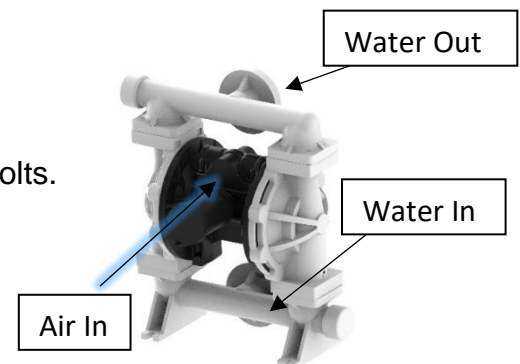

Figure 4.7-Chemical Transfer Pump

Water Tanks

1. Place Water Tank on trailer in desired location.
2. Use included mounts to attach tank to trailer deck.

Dry Mix Agitate

1. Refer to **DOC400018**.



Gas Can Kit

Refer to Quick Start Guide **DOC400060** for detailed instructions.

1. Using supplied 1/4" carriage bolts attach carrier near bottom of Dash frame beside inductor D.
2. Place gas can into carrier, using the holes in the carrier to attach straps to secure gas can.
3. Place nozzle into one of the unused valve holes



Aux Fill Kit (Side/Rear)

Refer to Quick Start Guide **DOC400048** (side) or **DOC400049** (rear) for detailed instructions.

1. Remove cap from auxiliary port on side of trailer manifold.
2. Attach 90° hose barb to port. Point the barb inwards to the trailer.
3. If side refill kit, drill two 7/16" holes in the I-beam directly across from where the barb is pointing. If rear refill kit, drill two holes on desired beam near rear of the trailer, where a double I-beam is present. Use the mounting bracket on valve as a template to determine how far apart the holes are drilled.
4. In the holes you drilled, use the provided hardware to bolt the valve to the trailer.
5. Cut hose so it is tight when run between 90" sweep and valve.
6. Run hose from sweep to valve and attach on both ends. Support hose where it sags.



Tank Fill (3/4" / 2")

Refer to Quick Start Guide **DOC400064** (2") or **DOC400067**(3/4") for detailed instructions.

1. Drill holes and attach fill valve to edge of trailer deck using supplied fasteners.
2. Drill appropriately sized hole (3/4" or 2") in the top of the tank.
3. Place float valve in drilled hole, secure using bulkhead.
4. Attach hose between float valve and fill valve, trim if necessary.

Fuel Tank

1. Place fuel tank under tote platform and air tank, if so equipped.
2. Mount fuel tank to trailer deck through tank feet.
3. Connect fuel pump to battery.

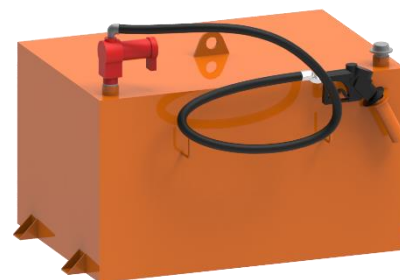

Free Standing Tote Deck

1. Use supplied $\frac{1}{2}$ " x $1\text{-}1/4$ " carriage bolts to bolt Platform legs to Platform.
2. Use supplied $3/8$ " x 1 " carriage bolts to bolt Platform Gusset to Tote Platform.
3. Use supplied $\frac{1}{2}$ " x $4\text{-}1/2$ " bolts to bolt platform gusset to platform legs.
4. Place platform in desired location on trailer.
5. Drill $11/16$ " holes through trailer deck through Platform feet.
6. Insert $5/8$ "x 2 " carriage bolts through Platform feet. Ensuring to use deck support bracket under deck.



Filter Kit

Refer to Quick Start Guide **DOC400065** for detailed instructions.

1. Drill holes in desired mounting location (usually I-beams underneath trailer)
2. Attach mounting plates to deck using supplied fasteners. (Regular bolts for this step, not the U-bolts). Let it remain loose.
3. Use the U-bolts to attach filter kit to the mounting plates. Tighten the bolts from step two.
4. Use a clamp to attach the inlet hose to the hose flange on the filter kit.
5. For use, disconnect QDC cap and attach outlet hose to QDC fitting.



Ramp Kit

Refer to Quick Start Guide **DOC400047** for detailed instructions.

1. Place ramp holders under trailer deck in desired location.
2. Drill two $7/16$ " holes in the deck, 2.5 inches apart. 60 inches from these holes, drill two more holes, also 2.5 inches apart. There should be four holes total, and the holes should all be 6" from the edge of the deck. (Refer to below diagram)
3. Attach ramp hangers to deck using supplied fasteners.
4. Hang ramp from ramp hangers.

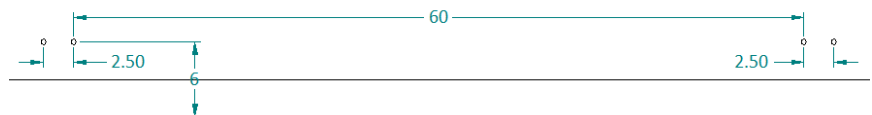
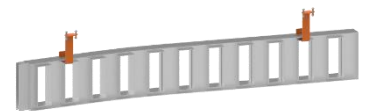

Air Tank Kit

1. Attach air tank to mounting holes in tote platform in desired location using supplied fasteners.
2. Attach air input to trailer brake reservoir.
3. Attach outlet to Dash air input.



Stacking Pump Kit

Refer to Quick Start Guide **DOC400079** (1" pump) or **DOC400080** (1½" pump) for detailed instructions.



1. Use bracket as a template to drill holes in the trailer deck (skip this step if mounting on top of another bracket)
2. Use supplied fasteners to attach pump and bracket together through drilled holes, or on top of another bracket. Stack the 1½" kits no further than 2 high, and the 1" kits no further than 3 high.

Solar Panel Kit

Refer to Quick Start Guide **DOC400078** for detailed instructions.

1. Fasten the solar panel to the tank hoops.
2. Use the included cable to attach the solar panel to the "SOLAR" port on the DASH's fuse box.



Boost Kit

Refer to Quick Start Guide **DOC400072** for detailed instructions.

1. Remove Linkage from master water valve.
2. Use the provided brackets to connect boost kit to valve using existing fasteners. Torque fasteners to 90 in/lbs (10nm).
3. Attach new linking components between the valves as shown and re-attach old linkage.
4. Use included tee to attach a hose coming from the boost valve to the hose going into the pump.
5. Attach a hose going to the boost valve from manifold (or intercepted from filter kit output using another tee, if applicable.)



Operation

Note: See motor manufacturers operators manual for all operational procedures concerning motor operation.

Pre-loading Products

Jugs and Liquid Products

1. Set Rinse Source to Water.
2. Pour product into desired inductor or use optional jug knife_[TW8]. **(Use extra caution when using jug knife)**
3. Place jug over rinse nozzle.

4. Push foot valve slowly down until you feel a click. This will send air through the nozzle and quickly empty the jug.
5. Once jug is empty, push foot valve completely down to rinse the jug. Release foot pedal **BEFORE** removing the jug.

Dry Products

1. Set Rinse Source to Water.
2. Pour product into inductor D (4.X) or inductor J (2.X).
3. Turn on the tank's Agitate function and fill inductor to desired volume.
4. Change Rinse Source to D (4.X) or J (2.X).
5. Turn on Agitate and let run for desired duration.

Loading the Sprayer

1. Load products into inductors.
2. Ensure Rinse Source is set to Water.
3. Connect loading hose to sprayer.
4. Open main valve.
5. Start engine. (Ensure there are no oil/fuel/liquid spills nearby)^[TW9]
6. Open the tank valve halfway to dump product into water stream, open all the way to rinse tank.

Note: Idle Dash pump down or turn pump off before closing sprayer valve, or pump may fail.

Cleaning the DASH

See Also DOC400006, see Honda manual for motor operational information

1. Set rinse source to water. Fill the left inductor D or J, depending on the model, with minimum 30 gal using the agitate valve.
2. Add cleaning agent to left inductor, also add the appropriate amount of cleaning agent for the sprayer.
3. Change the rinse source to inductor D or J (Figure 5.1).

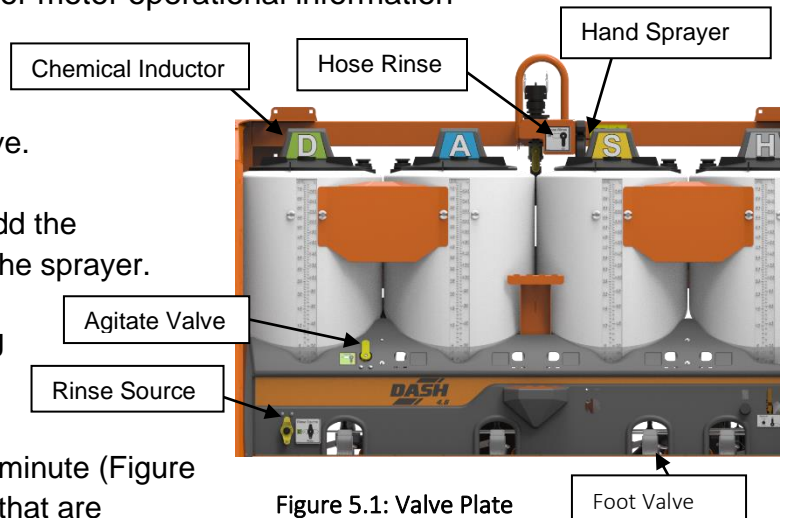

Figure 5.1: Valve Plate

4. Turn on the agitate valve and let run for 1 minute (Figure 5.1). Also, run any optional agitate valves that are installed.
5. Ensure main water valve (Figure 5.2) is closed and pump outlet is blocked then open all 4 of the inductor valves (Figure 5.2). The hand sprayer can be used to clean manually if desired.
6. Using the foot valves activate all jug rinse nozzles. If wishing to clean tote hoses, use the hose rinse valve to clean hoses venting into an inductor.

Follow cleaning agent's directions for time duration to sit before moving on to step 7.

7. Connect main hose to sprayer and empty all inductors using the gas-powered water pump (Figure 5.2). Close inductor valves when finished.
8. Change the rinse source to water and fill the left inductor D or J, depending on the model, with minimum 30 gal using the agitate valve. (Figure 5.1).
9. Turn on the agitate valve and let run for 30 seconds (Figure 5.1). Also, run any optional agitate valves that are installed.
10. Ensure main water valve is closed and open all 4 of the inductor valves. If hand sprayer was used in step 5, let it run until cleaning agent is flushed out.
11. Using the foot valves activate all jug rinse nozzles until cleaning agent is flushed out.

If tote hoses were cleaned in step 5, use the hose rinse valve to rinse hoses venting into an inductor.

12. Connect main hose to sprayer and empty all inductors using the gas-powered water pump (Figure 5.2). Add more fresh water as needed for sprayer rinse.

13. Using foot valves activate all jug rinse nozzles and let run for 1 minute.

14. Turn on the agitate valve (Figure 5.1) and fill left inductor with enough fresh water to push any rinse water out of the main water hose.

15. Change the rinse source to inductor D or J (Figure 5.1).

16. Turn on the agitate valve and let run for 30 seconds (Figure 5.1).

17. Turn the rinse source back to water (Figure 5.1).

18. Empty the remaining rinse water in the inductors into the sprayer.

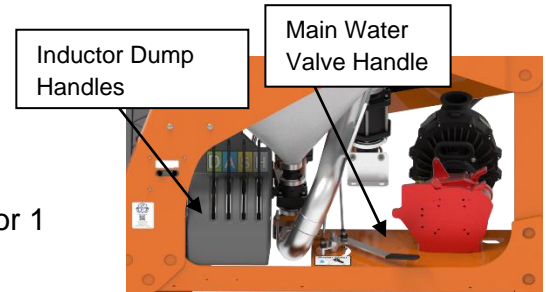

Figure 5.2: Chemical Dump Handles and Pump Motor

Service and Maintenance

Winterizing

1. Disconnect 3" water line from DASH and the 1" or 1-1/2" water line from tank.
2. Drain water from Dash.
3. Release drain on 3" pump to drain all liquid.
4. Run all installed agitate valves to vent water from lines. (Figure 5.1)
5. Open all the inductor valves (Figure 5.2). Using foot valves activate all jug rinse nozzles to vent hoses. (Figure 5.1)
6. Place 1" or 1-1/2" water line in jug of antifreeze.
7. Set Rinse Source to Water. (Figure 5.1)
8. Turn on all installed Agitate valves for 5 sec.
9. Turn on each inductors Rinse valves for 5 sec.

10. Set Rinse Source to D or J. (Figure 5.1)
11. Turn on all installed Agitate valves for 5 sec. (Figure 5.1)
12. Turn on Hand Sprayer for 5 sec. (Figure 5.1)
13. Ensure the main water valve is closed. (Figure 5.2)
14. Open each inductor dump valves in turn. (Figure 5.2)
15. Close inductor dump valves. (Figure 5.2)
16. Perform storage precautions for engine found in engine manual.

Springtime Preparation

1. Perform pre-operation checks found in Honda manual for Honda engine.
2. Ensure the 3" pump's wet seal reservoir is full with 50/50 mix of antifreeze and water.
3. Attach water hoses to DASH.
4. Set Rinse Source to Water. (Figure 5.1)
5. Turn on all installed Agitate valves and let run for 30 sec. (Figure 5.1)
6. Open inductor valves to turn on all the inductor rinse valves. Let run for 1 minute. (Figure 5.2)
7. Use foot valves to activate all jug rinse nozzles until the antifreeze is flushed out.
8. Turn on Hand Sprayer and let it run until the antifreeze is flushed out. (Figure 5.1)
9. Use gas driven pump to empty rinse water out of inductors and main water line.
10. Dispose of antifreeze per local regulations.
11. DASH ready for next season.

Proper maintenance of the Dash will result in more reliable performance. Please refer to the chart below for recommended maintenance information:

Key		Maintenance Record											
✓	check	hours											
●	lubricate	by											
◇	clean	date											
▲	change												
⌘	hours												
Every Use													
✓	Engine Oil												
✓	Engine Air Filter												
50 ⌘													
▲	Engine Oil												
●	Air Pump Grease												
●	Handle Box Pivot												
●	Agitate Kit Lubricator												
Air diaphragm pump (Perform maintenance as necessary, i.e. if pump is leaking.)													
	Torque												
	Service shuttle valve												

See Engine Operators Manual for engine related maintenance.

See Pump Manual for maintenance of the 3" pump.

Refer to page 14 for torque specs.



Rear Mount Dash Light Schematic

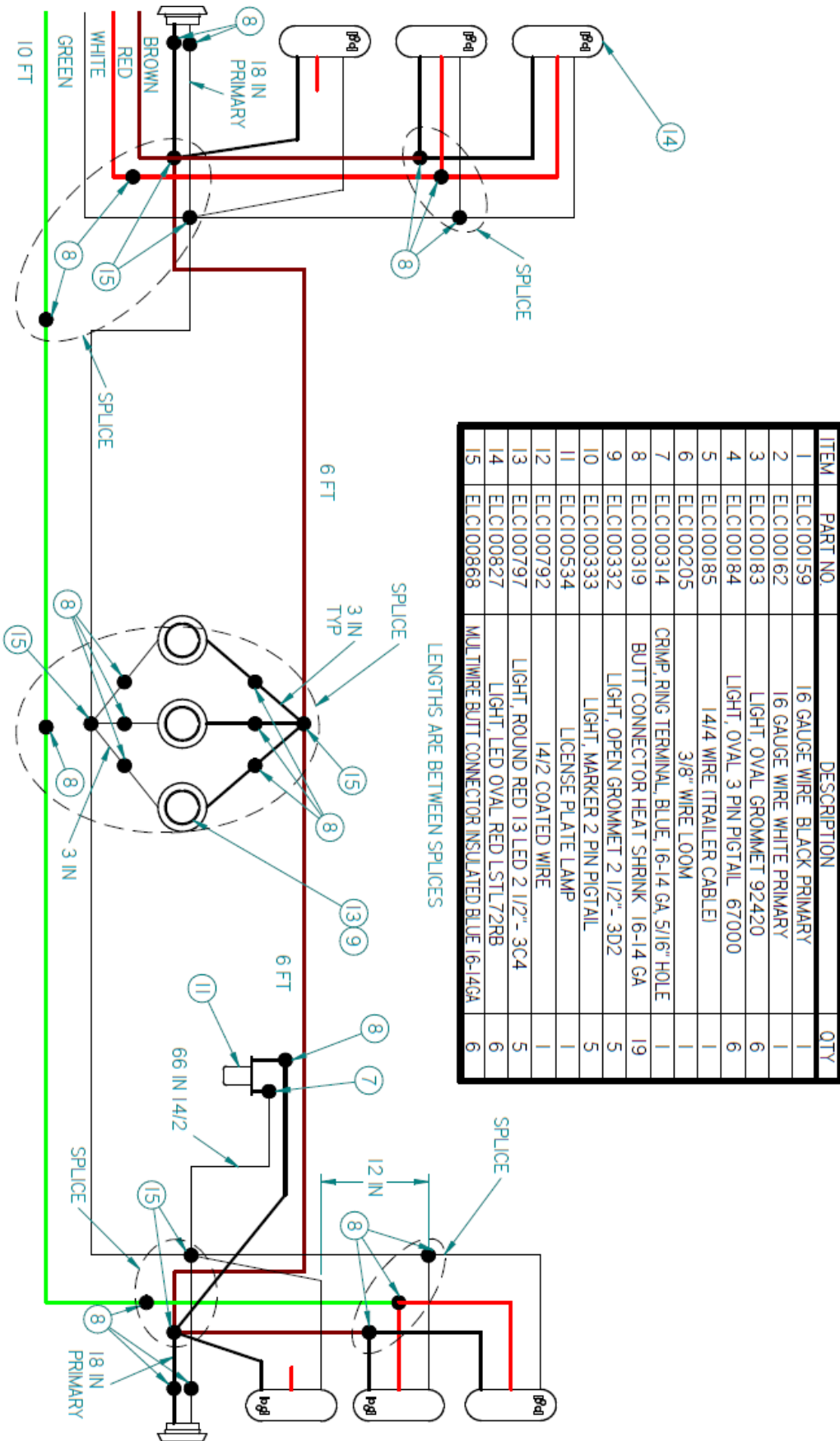

Troubleshooting

SYMPTOM	POSSIBLE CAUSE	SOLUTION
Air pump locks up	Pressure equalization in pump Lack of lubrication on O-Ring seals	Vent pressure from airline and reapply. Also see air diaphragm pump manual Clean air chamber and re-lubricate seals
Tank fill with water	Misalignment of valve handles Torque ball valve	Realign valve rods. Retorque valves
Pump cavitation	Misalignment of valve handles Torque ball valve	Realign valve rods. Retorque valves
Boom not latching	Boom too high or low	Adjust tie rod link
Air diaphragm pump leaks	Loose/uneven fasteners	Re-torque fasteners (refer to page 22)
Boom blowout kit doesn't operate	Broken electrical connection	Check the connection of the harness to the battery. Check voltage between pin 1 and 2 of connector X-001 (should be 12v) Ensure fuse has not blown, replace if necessary
Foot pedal is sticking	Fasteners too tight	Loosen fasteners that attach aluminum pedal to link arms (Figure 6.1)
Foot pedal is leaking	Loose water line adapter	Zip tie across the pedal mechanism's frame so that the water line is held in place. (Figure 6.1)

For engine troubleshooting, see engine manual.

For pump troubleshooting, see pump manual.

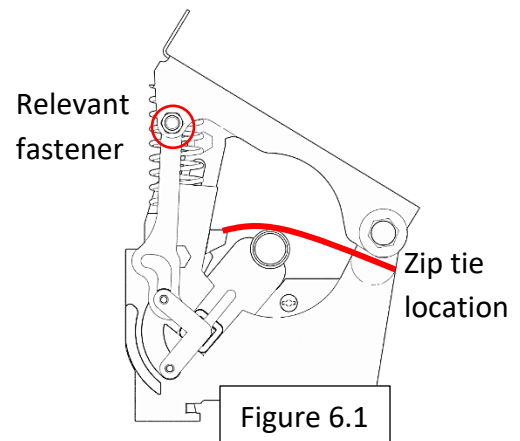

INDEX

A	
Assembly Illustration	2
M	
Mounting and Installation	15
Air Tank Kit.....	24
Aux Fill Kit	23
Aux. Chem Meter	21
Bag Holder Kit	17
Boom	19
Boom Blowout Kit.....	20
Cage.....	16
Cage Transfer Hose	16
Chemical Transfer Pump.....	22
DASH	15
Deck Bulkhead	21
Dry Agitate Kit	22
Filter Kit	24
Fire Nozzle Kit.....	20
Free Standing Tote Deck.....	23
Fuel Tank Kit.....	23
Gas Can Kit.....	22
Hose Reel.....	22
Jug Knife Kit	21
Ladder Kit.....	17
Light Kit	19
Manifold Kit.....	21
Platform Strap Kit	18
Ramp Kit.....	24
Tank Fill Kit.....	23
Tote Platform	17
Tote Rinse Kit	17
Tote Strap Kit.....	19
Tote Transfer Hose.....	18
Trailer Lighting Kit.....	19
Trailer Step Kit.....	20
Water Tanks	22
Working Platform	15
O	
Operation	25
Cleaning	26
Loading Sprayer	25
Preload Products	25
Safety	4
S	
Safety	
Alert Symbols	4
Chemical Safety.....	7
General Safety Practices	5
Installation Safety	8
Maintenance Safety	6
Operator Responsibility	5
Safety Sign Maintenance	12
Signs.....	10
Storage Safety	9

Transport Safety.....	8
Water Safety.....	7
Schematic	
Lights.....	30
Serial Number Plate.....	3
Service and Maintenance	27
Hourly Record	29
Pre-season	28

Winterizing.....	27
Specifications	13

T

Torque Specifications.....	14
Troubleshooting	31



PhiBer Manufacturing Inc.
Box 58 Crystal City, MB
Canada R0K 0N0